



CAT 4690-MH/US Metal Hose

Flexible Braided Hose 2018



ENGINEERING YOUR SUCCESS.



Parflex Division - Ravenna, OH

Extra care is taken in the preparation of this literature but Parker is not responsible for any inadvertent typographical errors or omissions. Information subject to change without notice. The information in this catalog is only accurate as of the date of publication. For a more current information base, please consult the Parflex Division web site at www.parker.com/pfd.



FAILURE OR IMPROPER SELECTION OR IMPROPER USE OF THE PRODUCTS AND/OR SYSTEMS DESCRIBED HEREIN OR RELATED ITEMS CAN CAUSE DEATH, PERSONAL INJURY AND PROPERTY DAMAGE.

This document and other information from Parker Hannifin Corporation, its subsidiaries and authorized distributors provide product and/or system options for further investigation by users having technical expertise. It is important that you analyze all aspects of your application and review the information concerning the product or system in the current product catalog. Due to the variety of operating conditions and applications for these products or systems, the user, through its own analysis and testing, is solely responsible for making the final selection of the products and systems and assuring that all performance, safety and warning requirements of the application are met.

The products described herein, including without limitation, product features, specifications, designs, availability and pricing, are subject to change by Parker Hannifin Corporation and its subsidiaries at any time without notice.

Offer of Sale

The items described in this document are hereby offered for sale by Parker Hannifin Corporation, its subsidiaries or its authorized distributors. This offer and its acceptance are governed by the provisions stated in the "Offer of Sale".

©2018 Parker Hannifin Corporation, All Rights Reserved

Table of Contents

Why Parflex Metal Hoses and Assemblies are Superior	2
Metal Hose Size and Performance Specifications	4-9
• 9A General Purpose Metal Hose	4
• 9M Ultra Flexible Metal Hose	6
• 9P High Pressure Metal Hose	8
• Metal Hose Assembly Nomenclature	10-11
• 9A and 9M Metal Hose Nomenclature	10
• 9P Metal Hose Nomenclature	11
Industrial & Instrumentation Fittings	12
ANSI B16.5 Flange Fittings	13
Technical Information	14-22
• Velocity in Metal Hoses	14
• Temperature Derating	14
• Pressure Drop Charts.....	15
• Pressure Rating of Hose End Connections	16
• Testing, Cleaning & Packaging Specifications	17
• Corrosion Resistance Chart	18
• Do's & Don'ts Illustrations	20
• Length Calculations Illustrations	21
• Metal Hose Selection (STAMPED Form)	22
Parker Safety Guide	23
Offer of Sale	27

Parflex Metal Hoses

The Superior Product

Parflex metal hose assemblies are designed for applications where chemicals and temperature extremes, either from media or atmosphere, are present.



FACTORY WELDED AND READY TO INSTALL

Any hose assembly is only as good as its weakest link. In the case of metal hose assembly, the weakest link can be the welding process. The proprietary methods of seam and splice welding, as well as fitting attachment, utilized in Parflex assemblies are second to none and yield a consistent, reliable, leak-free connection.

The 9A and 9M Parflex Metal Hose products are constructed with a 300 series stainless steel (SS) core tube

and produced using proprietary manufacturing methods. These methods, detailed below, minimize residual stress in the core material and maintain a consistent tube wall thickness throughout the hose, resulting in enhanced flexibility and cycle life.

Core Manufacturing Methods

- **Hydroforming:** Forms corrugations by expanding the core utilizing high pressure water
- **Crimp forming:** Forms corrugations by compressing stainless steel core utilizing a specialized shutter crimp

The 9P metal hose is the newest Parflex Metal Hose and is manufactured utilizing equivalent proprietary core tube production processes as the 9A and 9M constructions. With up to 2 layers of 321 stainless steel (SS) braid, the 9P hose is designed for applications with pressures up to 6000 psi.

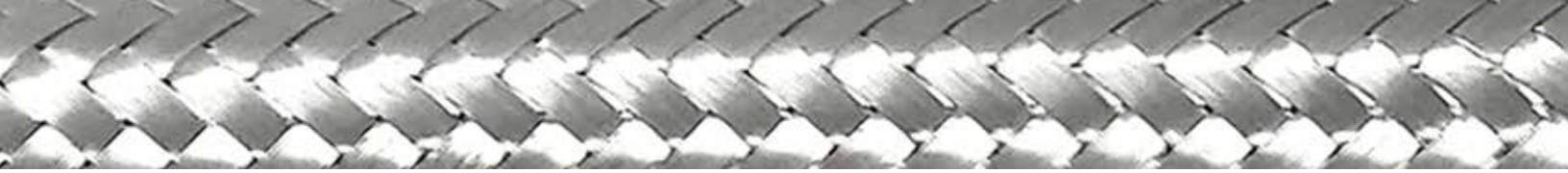

Product Features

- Excellent chemical resistance
- Sizes 1/4" I.D. up to 12" I.D.
- Proprietary Core Tube Manufacturing Process - Yields a uniform wall thickness, promoting even distribution of stress during flexing and reduces concentrated residual stress
- Full Vacuum - Maintains its shape under full vacuum, other hose types collapse
- Maintains its integrity up to 1200°F
- Zero permeation
- Leak-free fitting weld connection



Parflex metal hose assemblies are leak-free, full vacuum hose solutions.

9A - Standard



Features:

- Proprietary core tube manufacturing process yields uniform wall thickness, improved flexibility and life cycle
- High percentage braid coverage yields improved life cycle and protection against core tube damage

Applications/Markets



- Abrasion and over bending – as a protective cover over wires or other hoses to prevent these problems
- Chemical transfer
- Diesel engine exhaust
- Hot oil and lube lines
- Loading/unloading of light oils, gas, and chemicals
- Petrochemical
- Power Gen
- Pulp & Paper
- Solvent and steam lines

Construction

Tube: 300 series SS, Annular profile

Reinforcement: 300 series SS braid: 0, 1 or 2 layers

Reference: Metal Hose Assembly Nomenclature for available materials

Operating Parameters

Temperature Range

-380°F (-228°C) to 1200°F (648°C)

Working Pressure:

Vacuum (28in/Hg) to 2700 psi depending on assembly specifications

Notes

- STAMPED (Hose Selection Criteria) - pg 22
- For ordering information, consult “Parflex Metal Hose Assembly Nomenclature” - pg 10
- To calculate a working pressure derated for elevated temperature see "Working Pressure Derating Factor for Elevated Temperatures" - pg 14



WARNING

This product can expose you to chemicals including Lead, which is known to the State of California to cause cancer and birth defects or other reproductive harm. For more information go to www.P65Warnings.ca.gov.

9A General Purpose Hose Metal Hose Size and Performance Specifications						
Inside Diameter (in.)	Number of Braids (#)	Outside Diameter (in.)	Min. Bend Radius (in.)	Maximum Working Pressure (psi)	Burst Pressure (psi)	Weight per Foot (lbs.)
1/4	0	0.41	4.5	90		0.04
	1	0.47		1,800	7,233	0.11
	2	0.53		2,700	9,100	0.18
3/8	0	0.65	5.0	70		0.10
	1	0.71		1,558	6,230	0.20
	2	0.77		2,336	9,345	0.30
1/2	0	0.77	5.5	70		0.11
	1	0.83		1,186	4,743	0.22
	2	0.89		1,779	7,115	0.33
5/8	0	0.96	7.0	57		0.17
	1	1.02		1,205	4,820	0.33
	2	1.08		1,808	7,230	0.49
3/4	0	1.16	8.0	43		0.19
	1	1.22		898	3,591	0.37
	2	1.28		1,347	5,387	0.55
1	0	1.47	9.0	43		0.26
	1	1.53		718	2,872	0.50
	2	1.59		1,077	4,308	0.74
1-1/4	0	1.75	10.0	43		0.29
	1	1.83		645	2,581	0.61
	2	1.91		968	3,872	0.93
1-1/2	0	2.08	11.0	28		0.47
	1	2.16		531	2,125	0.85
	2	2.24		797	3,188	1.23
2	0	2.61	13.0	14		0.59
	1	2.69		449	1,797	1.11
	2	2.77		674	2,696	1.63
2-1/2	0	3.40	16.0	14		0.84
	1	3.50		417	1,669	1.64
	2	3.60		626	2,504	2.44
3	0	3.88	18.0	14		1.18
	1	3.98		346	1,384	2.06
	2	4.08		519	2,076	2.94
4	0	4.96	22.0	14		1.41
	1	5.06		299	1,194	2.69
	2	5.16		448	1,791	3.97
5	0	6.00	28.0	14		2.18
	1	6.12		275	1,099	3.61
	2	6.24		412	1,649	5.04
6	0	7.01	32.0	11		2.69
	1	7.13		210	839	4.44
	2	7.25		315	1,259	6.19

Sizes 8", 10" and 12" available for special order. Contact Parflex Division for further information regarding these sizes.



WARNING

This product can expose you to chemicals including Lead, which is known to the State of California to cause cancer and birth defects or other reproductive harm. For more information go to www.P65Warnings.ca.gov.

9M - Ultra Flexible



Features:

- Compressed corrugations for increased flexibility
- Proprietary core tube manufacturing process yields uniform wall thickness, improved flexibility and life cycle
- High percentage braid coverage yields improved life cycle and protection against core tube damage

Applications/Markets



- Abrasion and over bending – as a protective cover over wires or other hoses to prevent these problems
- Chemical transfer
- Diesel engine exhaust
- Hot oil and lube lines
- Loading/unloading of light oils, gas, and chemicals
- Petrochemical
- Power Gen
- Pulp & Paper
- Solvent and steam lines

Construction

Tube: 300 series SS, Annular profile

Reinforcement: 300 series SS braid: 0, 1 or 2 layers

Reference: Metal Hose Assembly Nomenclature for available materials

Operating Parameters

Temperature Range

-380°F (-228°C) to 1200°F (648°C)

Working Pressure:

Vacuum (28in/Hg) to 2700 psi depending on assembly specifications

Notes

- STAMPED (Hose Selection Criteria) - pg 22
- For ordering information, consult “Parflex Metal Hose Assembly Nomenclature” - pg 10
- To calculate a working pressure derated for elevated temperature see "Working Pressure Derating Factor for Elevated Temperatures" - pg 14



WARNING

This product can expose you to chemicals including Lead, which is known to the State of California to cause cancer and birth defects or other reproductive harm. For more information go to www.P65Warnings.ca.gov.

9M Ultra Flexible Hose Metal Hose Size and Performance Specifications						
Inside Diameter (in.)	Number of Braids (#)	Outside Diameter (in.)	Min. Bend Radius (in.)	Maximum Working Pressure (psi)	Burst Pressure (psi)	Weight per Foot (lbs.)
1/4	0	0.42	3.7	90		0.07
	1	0.48		2,250	1,800	0.14
	2	0.54		3,375	2,700	0.20
3/8	0	0.65	4.0	70		0.15
	1	0.71		1,558	6,230	0.25
	2	0.77		2,336	9,345	0.36
1/2	0	0.77	4.4	70		0.18
	1	0.83		1,186	4,743	0.32
	2	0.89		1,779	7,115	0.47
5/8	0	0.96	5.6	57		0.19
	1	1.02		1,205	4,820	0.37
	2	1.08		1,808	7,230	0.54
3/4	0	1.16	6.4	43		0.31
	1	1.22		898	3,591	0.53
	2	1.28		1,347	5,387	0.74
1	0	1.47	7.1	43		0.41
	1	1.53		718	2,872	0.76
	2	1.63		1,077	4,308	1.11
1-1/4	0	1.75	7.9	43		0.63
	1	1.83		645	2,581	1.00
	2	1.91		968	3,872	1.37
1-1/2	0	2.08	8.7	28		0.70
	1	2.16		531	2,125	1.16
	2	2.24		797	3,188	1.63
2	0	2.61	10.3	14		0.88
	1	2.69		449	1,797	1.44
	2	2.77		674	2,696	1.99
2-1/2	0	3.40	12.8	14		1.36
	1	3.50		417	1,669	2.16
	2	3.60		626	2,504	2.96
3	0	3.88	14.5	14		1.63
	1	3.98		346	1,384	2.50
	2	4.08		519	2,076	3.37
4	0	4.96	17.4	14		2.53
	1	5.06		299	1,194	3.90
	2	5.16		448	1,791	5.29
5	0	6.00	21.9	14		4.07
	1	6.12		275	1,099	5.53
	2	6.24		412	1,649	6.99
6	0	7.01	25.0	11		4.46
	1	7.13		210	839	6.34
	2	7.25		315	1,259	8.22



WARNING

This product can expose you to chemicals including Lead, which is known to the State of California to cause cancer and birth defects or other reproductive harm. For more information go to www.P65Warnings.ca.gov.

9P - High Pressure



Features:

- Proprietary core tube manufacturing process yields uniform wall thickness, improved flexibility and life cycle
- High percentage braid coverage yields improved life cycle and protection against core tube damage

Applications/Markets



- Hot oil lines
- Petrochemical
- Power Gen
- Pulp & Paper
- Solvent and steam lines

Construction

Tube: Heavy wall 300 series SS, Annular profile
Reinforcement: 321 SS Braid - 1 or 2 layers

Reference: Metal Hose Assembly Nomenclature for available materials

Operating Parameters

Temperature Range

-380°F (-228°C) to 1200°F (648°C)

Working Pressure:

Vacuum (28in/Hg) to 6000 psi depending on assembly specifications

Notes

- STAMPED (Hose Selection Criteria) - pg 22
- For ordering information, consult "Parflex Metal Hose Assembly Nomenclature" - pg 11
- To calculate a working pressure derated for elevated temperature see "Working Pressure Derating Factor for Elevated Temperatures" - pg 14



WARNING

This product can expose you to chemicals including Lead, which is known to the State of California to cause cancer and birth defects or other reproductive harm. For more information go to www.P65Warnings.ca.gov.

9P High Pressure Hose Metal Hose Size and Performance Specifications						
Inside Diameter (in.)	Number of Braids (#)	Outside Diameter (in.)	Min. Bend Radius (in.)	Maximum Working Pressure (psi)	Burst Pressure (psi)	Weight per Foot (lbs.)
1/4	1	0.56	4.5	5000	20000	0.32
	2	0.68		6000	24000	0.49
3/8	1	0.80	7.0	3500	14000	0.46
	2	0.92		5000	20000	0.77
1/2	1	0.88	8.0	2700	10800	0.64
	2	0.98		4500	18000	0.85
3/4	1	1.28	10.0	2650	10669	1.09
	2	1.40		3600	14521	1.58
1	1	1.57	11.0	2500	10000	1.53
	2	1.70		3000	12083	2.25
1-1/4	1	1.88	12.5	1775	7119	2.09
	2	2.00		2600	10400	2.88
1-1/2	1	2.23	13.0	1450	5800	2.64
	2	2.36		2200	8892	3.57
2	1	2.70	14.0	1100	4415	3.23
	2	2.82		1675	6710	4.45
2-1/2	1	3.51	16.0	700	2800	4.29
	2	3.63		1050	4200	5.59
3	1	3.83	20.0	600	2400	4.39
	2	3.95		900	3600	5.67
4	1	4.94	26.0	525	2100	6.94
	2	5.07		875	3500	8.80



WARNING

This product can expose you to chemicals including Lead, which is known to the State of California to cause cancer and birth defects or other reproductive harm. For more information go to www.P65Warnings.ca.gov.

9A and 9M Metal Hose Nomenclature



9A 1 TU 01 06 06 06 C - 30

9A	Hose Series	1	Code #	TU-01	First and Second End Connection*
	9A – General Purpose 9M – Ultra Flexible		0 – 321 SS core, No braid 1 – 321 SS core, 304 SS single braid 2 – 321 SS core, 304 SS double braid 3 – 316 SS core, No braid 4 – 316 SS core, 304 SS single braid 5 – 316 SS core, 304 SS double braid 6 – 321 SS core, 316 SS single braid 7 – 321 SS core, 316 SS double braid 8 – 316 SS core, 316 SS single braid 9 – 316 SS core, 316 SS double braid 9A & 9M - Available in all core/braid constructions		01 – Male Pipe Thread (with hex) - NPT 02 – Female Pipe Thread - NPT 06 – Female JIC 37° Flare Swivel U7 – Female Pipe Union - NPT TU – Universal Tube Stub JC – Female Oring Face Seal (ORFS) Swivel AL – A-lok® Compression 9K – Raised Face Weld Neck 150lb Fixed Flange 9Y – Raised Face Weld Neck 300lb Fixed Flange 4K – Schedule 40 Type A Stub, 150lb Lap Joint (Floating) Flange 1Y – Schedule 40 Type A Stub, 300lb Lap Joint (Floating) Flange 8K – Raised Face 150lb Fixed Slip-on Flange 8Y – Raised Face 300lb Fixed Slip-on Flange

06	First End Size	06	Second End Size	06	Hose Size	C	Fitting Material	30	Overall Length
	-4 = 1/4		-4 = 1/4		-4 = 1/4		Stainless Steel - C (300 series SS)		Expressed in inches
	-6 = 3/8		-6 = 3/8		-6 = 3/8		316 Stainless Steel - K (required if 316 SS is specified/suggested)		
	-8 = 1/2		-8 = 1/2		-8 = 1/2				
	-10 = 5/8		-10 = 5/8		-10 = 5/8				
	-12 = 3/4		-12 = 3/4		-12 = 3/4				
	-16 = 1		-16 = 1		-16 = 1				
	-20 = 1-1/4		-20 = 1-1/4		-20 = 1-1/4				
	-24 = 1-1/2		-24 = 1-1/2		-24 = 1-1/2				
	-32 = 2		-32 = 2		-32 = 2				
	-40 = 2-1/2		-40 = 2-1/2		-40 = 2-1/2				
	-48 = 3		-48 = 3		-48 = 3				
	-64 = 4		-64 = 4		-64 = 4				
	-80 = 5		-80 = 5		-80 = 5				
	-96 = 6		-96 = 6		-96 = 6				

* Not all fitting configurations are available in full array of sizes.



WARNING

This product can expose you to chemicals including Lead, which is known to the State of California to cause cancer and birth defects or other reproductive harm. For more information go to www.P65Warnings.ca.gov.

9P Metal Hose Nomenclature



9P C TU 01 08 08 08 C - 30

9P	Hose Prefix	C	Code #	TU-01	First and Second End Connections*
	9P - High Pressure		<p>A: 321 SS core 321 SS single braid</p> <p>B: 321 SS core 321 SS double braid</p> <p>C: 316 SS core 321 SS single braid</p> <p>D: 316 SS core 321 SS double braid</p> <p>Not all core/braid combinations are available in all sizes</p> <p>-1/4" - 1/2": Available in C & D constructions only</p> <p>-2.5" - 4": Available in A & B constructions only</p>		<p>01 – Male Pipe Thread (with hex) - NPTF</p> <p>02 – Female Pipe Thread - NPT</p> <p>06 – Female JIC 37° Flare Swivel</p> <p>U7 – Female Pipe Union - NPT</p> <p>TU – Universal Tube Stub</p> <p>JC – Female Oring Face Seal (ORFS) Swivel</p> <p>AL – A-lok® Compression</p>

08	First End Size	08	Second End Size	08	Hose Size	C	Fitting Material	30	Overall Length
	<p>-4 = 1/4</p> <p>-6 = 3/8</p> <p>-8 = 1/2</p> <p>-12 = 3/4</p> <p>-16 = 1</p> <p>-20 = 1-1/4</p> <p>-24 = 1-1/2</p> <p>-32 = 2</p> <p>-40 = 2-1/2</p> <p>-48 = 3</p> <p>-64 = 4</p>		<p>-4 = 1/4</p> <p>-6 = 3/8</p> <p>-8 = 1/2</p> <p>-12 = 3/4</p> <p>-16 = 1</p> <p>-20 = 1-1/4</p> <p>-24 = 1-1/2</p> <p>-32 = 2</p> <p>-40 = 2-1/2</p> <p>-48 = 3</p> <p>-64 = 4</p>		<p>-4 = 1/4</p> <p>-6 = 3/8</p> <p>-8 = 1/2</p> <p>-12 = 3/4</p> <p>-16 = 1</p> <p>-20 = 1-1/4</p> <p>-24 = 1-1/2</p> <p>-32 = 2</p> <p>-40 = 2-1/2</p> <p>-48 = 3</p> <p>-64 = 4</p>		<p>Stainless Steel - C (300 series SS)</p> <p>316 Stainless Steel - K (required if 316 SS is specified/suggested)</p>		Expressed in Inches

* Not all fitting configurations are available in full array of sizes



WARNING

This product can expose you to chemicals including Lead, which is known to the State of California to cause cancer and birth defects or other reproductive harm. For more information go to www.P65Warnings.ca.gov.

Fittings

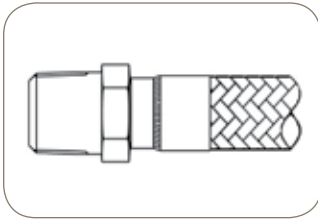

01 - Male Pipe Thread
(with hex) - NPTF

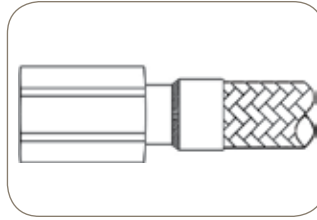

02 - Female Pipe Thread
NPT

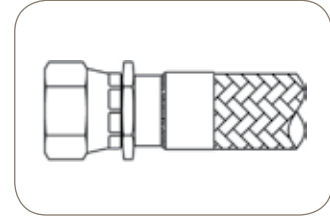

*06 - Female JIC 37°
Flare Swivel

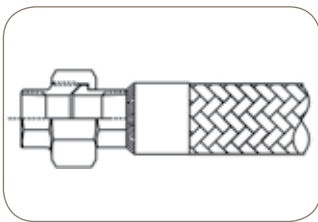

U7 - Female Pipe Union NPT

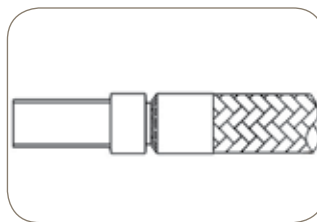

TU - Universal Tube Stub

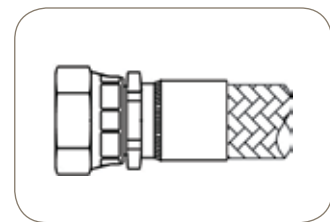

JC - Female Oring Face Seal
(ORFS) Swivel

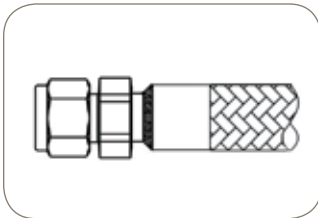

AL - A-lok® Compression

*06-Female JIC swivel connections are available with and without the back-up hex. End users must specify fitting preference at the time of quote.

Drawings are for illustration purposes only.

All A-LOK® Instrumentation connections are Genuine Parker Instrumentation products. For specific information regarding these products, consult Parker catalog 4230/4233.

End user must ensure that the selected fittings are chemically compatible with and are able to withstand the pressure and temperatures of the fluid media, the surrounding environment and application. Reference Safety Bulletin 4400-B.1.



WARNING

This product can expose you to chemicals including Lead, which is known to the State of California to cause cancer and birth defects or other reproductive harm. For more information go to www.P65Warnings.ca.gov.

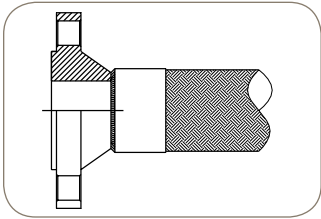

9K - Raised Face Weld Neck
150lb Fixed Flange

9Y - Raised Face Weld Neck
300lb Fixed Flange

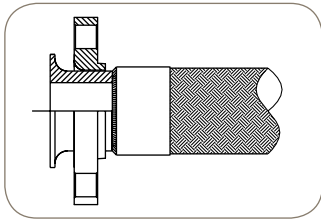

4K - Schedule 40 Type A Stub,
150lb Lap Joint (Floating) Flange

1Y - Schedule 40 Type A Stub,
300lb Lap Joint (Floating) Flange

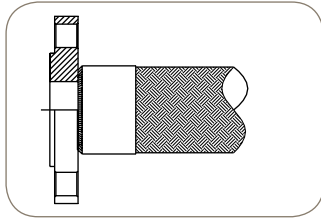

8K - Raised Face,
150lb Fixed Slip-on Flange

8Y - Raised Face,
300lb Fixed Slip-on Flange

Flange Identification for Parflex Metal Hose Assemblies

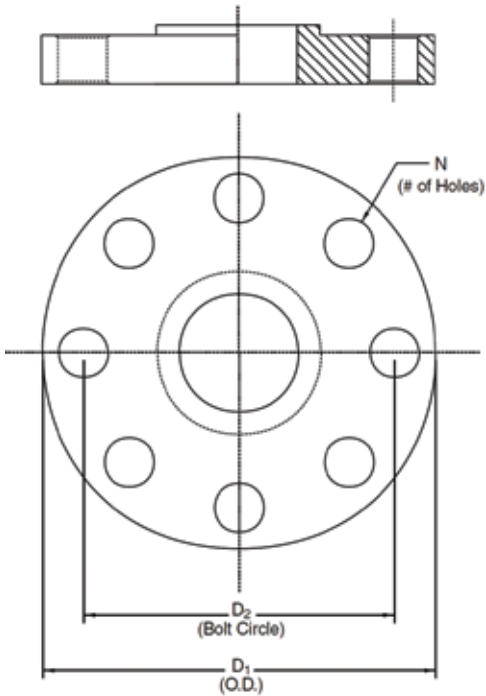

Drawings are for illustration purposes only. All flanges meet ANSI B16.5 specifications.

No hose assembly shall contain two fixed flanges to eliminate hose twisting. Combinations shall be either; 2 floating flange connections or 1 fixed and 1 floating connection.

Class 150			
Nominal Size	D ₁	D ₂	N
1/2"	3.50	2.38	4
3/4"	3.88	2.75	4
1"	4.25	3.12	4
1 1/4"	4.62	3.50	4
1 1/2"	5.00	3.88	4
2"	6.00	4.75	4
2 1/2"	7.00	5.50	4
3"	7.50	6.00	4
4"	9.00	7.50	8
5"	10.00	8.50	8
6"	11.00	9.50	8

Class 300			
Nominal Size	D ₁	D ₂	N
1/2"	3.75	2.62	4
3/4"	4.62	3.25	4
1"	4.88	3.50	4
1 1/4"	5.25	3.88	4
1 1/2"	6.12	4.50	4
2"	6.50	5.00	8
2 1/2"	7.50	5.88	8
3"	8.25	6.62	8
4"	10.00	7.88	8
5"	11.00	9.25	8
6"	12.50	10.62	8

WARNING This product can expose you to chemicals including Lead, which is known to the State of California to cause cancer and birth defects or other reproductive harm. For more information go to www.P65Warnings.ca.gov.

Velocity in Metal Hose

When gas or liquid being conveyed in a corrugated metal hose exceeds certain limits, resonant vibration can occur. Resonance may cause very rapid failure of the assembly.

In those applications where product velocities exceed the limits shown in the graph below, a revision of the assembly design might include:

- 1) Addition of an interlocked metal hose liner
- 2) An increase in the corrugated hose I.D.
- 3) A combination of the above

Velocity Chart

Installation Configuration	Maximum Product Velocity (Ft./Sec.)			
	Unbraided		Braided	
	Dry Gas	Liquid	Dry Gas	Liquid
Straight Run	100	50	150	75
45° Bend	75	40	115	60
90° Bend	50	25	75	40
180° Bend	25	12	38	19

Temperature Derating Chart

Working Pressure Derating Factor for Elevated Temperatures				
Temperature	Working Pressure Derating Factor			
°F	304	316	321	Carbon Steel
70	1.00	1.00	1.00	1.00
100	1.00	1.00	1.00	1.00
200	1.00	1.00	1.00	1.00
300	1.00	1.00	1.00	1.00
400	0.93	0.93	1.00	1.00
500	0.86	0.86	0.96	0.95
600	0.81	0.81	0.91	0.87
650	0.79	0.79	0.89	0.85
700	0.77	0.77	0.87	0.83
750	0.75	0.75	0.86	0.65
800	0.74	0.74	0.84	0.54
850	0.72	0.72	0.84	0.44
900	0.71	0.71	0.83	0.33
950	0.69	0.69	0.81	
1000	0.67	0.67	0.81	
1050	0.65	0.65	0.70	
1100	0.62	0.61	0.55	
1150	0.53	0.52	0.41	
1200	0.38	0.38	0.32	

To calculate a working pressure derated for elevated temperature: Multiply the hose working pressure shown in the catalog by the appropriate derating factor from above.

Note: The working pressure of an assembly at elevated temperatures may be affected by fitting type, material and method of attachment.

Pressure Drop

Pressure drop in a piping system is often a concern of the designer. Compared to rigid pipe, there is always a greater pressure drop in corrugated metal hose. The following graphics are offered as aids in estimating pressure drop in corrugated hose conveying water and air. The values derived are approximate and apply only to straight line installations. Bends and fittings in the hose assembly can increase the pressure drop.

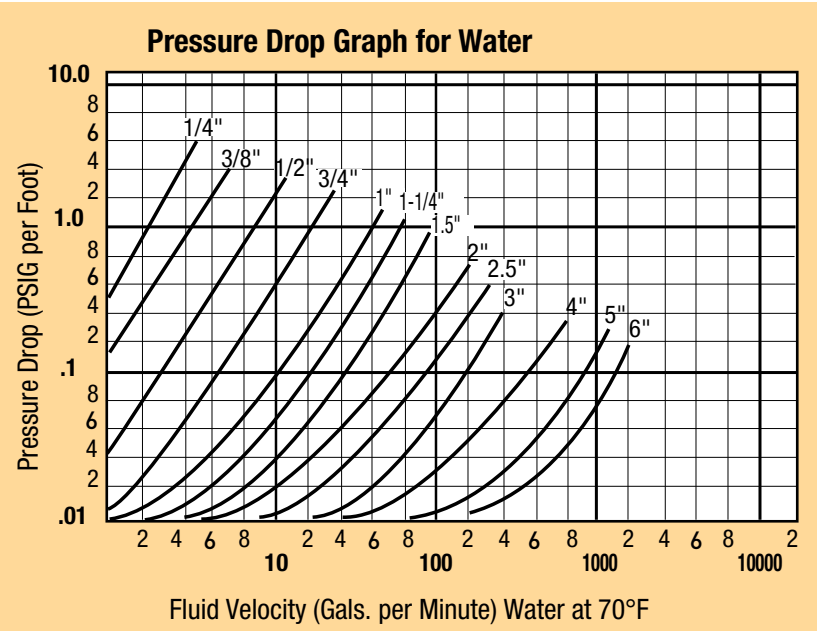

For air inlet pressures other than 100 psig:
 $PD = PD @ 100 \text{ psig}$

$$\left(\frac{100 + 14.7}{P + 14.7} \right)$$

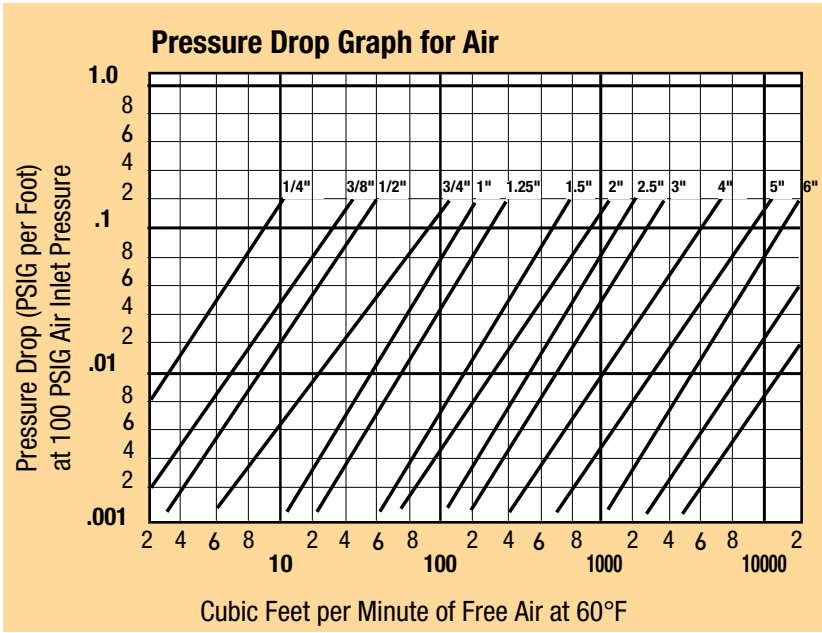

Pressure Rating of Hose End Connections

The maximum dynamic working pressure of the hose assembly is the lesser of the rated working pressure of the hose and the end connections used.

Hose End Connection	Part Number	Inch Fittings										
		-2	-4	-5	-6	-8	-10	-12	-16	-20	-24	-32
Description	Codes	psi (MPa)	psi (MPa)	psi (MPa)	psi (MPa)	psi (MPa)	psi (MPa)	psi (MPa)	psi (MPa)	psi (MPa)	psi (MPa)	psi (MPa)
Male Pipe (NPTF)	01, MT	12,000 (82.7)	12,000 (82.7)	-	10,000 (68.9)	10,000 (68.9)	-	7,500 (51.7)	6,500 (44.8)	5,000 (34.5)	3,000 (20.7)	2,500 (17.2)
Female Pipe (NPTF, NPSM)	02, 07	7,500 (51.7)	7,000 (48.3)	-	6,000 (41.4)	5,000 (34.5)	-	4,000 (27.6)	3,000 (20.7)	2,500 (17.2)	2,000 (13.8)	2,000 (13.8)
37° Flare and Straight Thread	03, 06	-	6,000 (41.4)	6,000 (41.4)	5,000 (34.5)	5,000 (34.5)	5,000 (34.5)	5,000 (34.5)	4,000 (27.6)	3,000 (20.7)	2,500 (17.2)	2,500 (17.2)
Seal-Lok® (O-Ring Face Seal)	JC	-	6,000 (41.4)	-	6,000 (41.4)	6,000 (41.4)	6,000 (41.4)	6,000 (41.4)	6,000 (41.4)	4,000 (27.6)	4,000 (27.6)	-
A-Lok®. CPI™	TU, AL, P6	-	6,000 (41.4)	6,000 (41.4)	5,600 (38.6)	5,600 (38.6)	4,200 (29.0)	4,200 (29.0)	3,500 (24.1)	3,500 (24.1)	3,000 (20.7)	3,000 (20.7)
VacuSeal™	HV, VH	-	5,100 (35.2)	-	3,300 (22.8)	3,500 (24.1)	-	2,400 (16.5)	2,400 (16.5)	-	-	-
UltraSeal™	Q1	-	5,400 (37.2)	-	4,300 (29.6)	3,600 (24.8)	-	3,900 (26.9)	-	-	-	-

End user must ensure that the selected fittings are chemically compatible with and are able to withstand the pressure and temperatures of the fluid media, the surrounding environment and application. Reference Safety Bulletin 4400-B.1

Refer to ANSI B16.5 specification for working pressures of all flange fittings

Testing, Cleaning & Packaging

Testing, Cleaning and Packaging of Parflex Metal Hose Assemblies				
Code	Testing ²	Cleaning	Packaging	Fittings/Welds
P1	General requirement (low pressure air under water)	General requirement	Bulk packed in cardboard box	As welded
P5	300 PSI Helium under water / 5 minutes	General requirement	Plastic mesh protectors - assemblies sealed in plastic bag	Welds buffed ¹ fittings polished (32 Ra)
P6	300 PSI Helium under water / 5 minutes	Oxygen cleaned per CGA G-4.1	Plastic mesh protectors - assemblies sealed in plastic bag	Welds buffed ¹ fittings polished (32 Ra)
P8	Helium leak test - leak rate < 1x10 ⁻⁵ cc/sec	Water flushed, hot air dried	Plastic mesh protectors - assemblies sealed in plastic bag	Welds buffed ¹ fittings polished (32 Ra)
P9	Helium leak test - leak rate < 1x10 ⁻⁷ cc/sec	Oxygen cleaned per CGA G-4.1	Plastic mesh protectors - assemblies sealed in plastic bag	Welds buffed ¹ fittings polished (32 Ra)
P10	Helium leak test - leak rate < 1x10 ⁻⁹ cc/sec	Oxygen cleaned per CGA G-4.1	Plastic mesh protectors - assemblies sealed in plastic bag	Welds buffed ¹ fittings polished (32 Ra)
P11	Customer specified	Customer specified	Customer specified	Customer specified

Footnotes

1. Buffing of welds will remove any heat discoloration due to welding, marker on hose, etc. All welds are argon purged.
2. With any gas under water test, the presence of bubbles would indicate failure.

Corrosion Resistance Chart

Caution: This information is offered only as a guide. Actual service life can only be determined by the end user by testing under all extreme conditions and other analysis. See Parker Safety Guide on page 23.

Ratings: 1 – Excellent Resistance
 2 – Good Resistance
 3 – Fair or Conditional Resistance
 X – Not Recommended

Notes: (A) Ratings are based on ambient temperature
 (B) No rating indicates no data available

	T321	T316
Acetate Solvents (crude)	1	2
Acetate Solvents (pure)	1	1
Acetic Acid 80%	1	1
Acetic Acid 50%	2	1
Acetic Acid 20%	2	1
Acetic Acid 10%	1	1
Acetic Anhydride	2	2
Acetone	1	1
Acetylene	1	1
Alcohols		
Amyl Alcohol	2	2
Benzyl Alcohol	1	1
Butyl Alcohol	1	1
Diacetone Alcohol	2	2
Ethyl Alcohol	2	2
Hexyl Alcohol	–	–
Isobutyl Alcohol	–	–
Isopropyl Alcohol	2	2
Methyl Alcohol	2	2
Octyl Alcohol	–	–
Propyl Alcohol	1	1
Aluminum		
Aluminum Chloride	X	X
Aluminum Fluoride (sat.)	X	2
Aluminum Nitrate (sat.)	2	2
Aluminum Potassium Sulfate	X	2
Aluminum Sulfate (sat.)	2	2
Alum	X	2
Ammonia		
Ammonia Anhydrous	2	1
Ammonia Gas	1	1
Ammonia Nitrate	–	–
Ammonium		
Ammonium Bifluoride	–	–
Ammonium Carbonate (sat.)	2	2
Ammonium Casenite	–	–
Ammonium Chloride (sat.)	X	X
Ammonium Hydroxide (sat.)	2	2
Ammonium Nitrate	–	–
Ammonium Phosphate	–	–
Ammonium Sulfate (10%-40%)	X	2
Aniline	1	1
Arsenic Acid	2	2
Barium		
Barium Carbonate (sat.)	2	2
Barium Chloride	X	2
Barium Hydroxide	2	2
Barium Sulfate	2	2
Barium Sulfide	2	2
Beer	1	1
Benzaldehyde	2	2

	T321	T316
Benzene, Benzol	2	2
Benzine	–	–
Benzoic Acid	2	2
Black Liquor	2	2
Bleach (12.5% chlorine)	–	X
Borax	2	1
Boric Acid	–	–
Brake Fluid	1	1
Brine Acid	–	–
Bromic Acid	–	–
Bromine Liquid	X	X
Butadene, Butylene	2	2
Butane	2	2
Butyl Acetate	2	2
Butyric Acid	2	2
Calcium		
Calcium Bisulfate	X	2
Calcium Bisulfide	–	–
Calcium Bisulfite	2	2
Calcium Carbonate	1	2
Calcium Chloride	–	–
Calcium Hydroxide	2	2
Calcium Hypochlorite (sat.)	X	2
Carbon		
Carbon Bisulfide	2	2
Carbon Dioxide (dry)	2	2
Carbon Dioxide (wet)	2	2
Carbon Disulfide	2	2
Carbon Monoxide	1	1
Carbon Tetrachloride	1	1
Carbonic Acid	2	2
Castor Oil	2	2
Caustic Potash	–	–
Cellosolves	2	2
Chlorine (liquid)	–	–
Chloroform	–	1
Chlorosulfonic Acid	X	X
Chromic Acid 50%	3	2
Citric Acid	–	–
Clorox (bleach) 5.5% CL	–	2
Coke Oven Gas	2	2
Copper		
Copper Chloride	X	X
Copper Cyanide	2	2
Copper Sulfate (sat.)	–	2
Creosylic Acid	2	2
Cyclohexane	2	2
Detergents	1	2
Dextrose	–	–
Diesel Fuels	1	1
Diethylamine	2	2

	T321	T316
Disodium Phosphate	–	1
Ethers	1	1
Ethyl		
Ethyl Acetate	2	2
Ethyl Chloride	1	1
Ethylene		
Ethylene Chloride	–	–
Ethylene Dichloride	2	2
Ethylene Glycol	2	2
Ethylene Oxide	2	2
Fatty Acids	–	1
Ferric		
Ferric Chloride	X	X
Ferric Hydroxide	1	1
Ferric Nitrate (10%-50%)	2	2
Ferric Sulfate	–	–
Ferrous		
Ferrous Chloride (sat.)	X	X
Ferrous Sulfate	2	2
Fluoboric Acid	–	–
Formaldehyde (50%)	1	1
Formic Acid (Anhyd)	–	–
Freon		
Freon 11	2	2
Freon 12 (wet)	2	2
Freon 22	2	2
Fruit Juice	2	2
Fuel Oils	2	2
Furfural	2	2
Gasoline		
Refined Gasoline	2	2
Sour Gasoline	2	2
Gelatine	2	2
Glucose	2	2
Glue	2	2
Glycerine	1	1
Glycol	2	2
Green Liquor	–	–
Heptane	2	2
Hexane	1	1
Hydrobromic Acid (50%)	X	X
Hydrobromic Acid (20%)	X	X
Hydrochloric Acid (20%)	X	X
Hydrochloric Acid (37%)	X	X
Hydrocyanic Acid	2	2
Hydrofluoric Acid	X	2
Hydrofluosilicic Acid	X	2
Hydrogen		
Hydrogen Peroxide (50%)	2	–
Hydrogen Sulfide (Aqueous)	X	2
Hydrogen Chloride (Gas, Dry)	–	–

	T321	T316
Hydrogen Gas	1	1
Hypochlorous Acid	X	X
Iodine	X	X
Isopropyl Ether	1	2
Jet Fuel (JP3, JP4, JP5)	2	2
Kerosene	2	2
Ketones	2	2
Lactic Acid (25%)	-	-
Lactic Acid (80%)	2	-
Lard Oil	2	2
Lead		
Lead Acetate	2	2
Lead Chloride	2	2
Lead Sulfate	2	2
Lime Sulphur	2	2
Linoleic Acid	2	2
Linseed Oil	2	2
Lubricants (Oil)	2	2
Magnesium		
Magnesium Carbonate	2	2
Magnesium Chloride	-	-
Magnesium Hydroxide	1	1
Magnesium Nitrate	2	2
Magnesium Oxide	-	-
Magnesium Sulfate	2	2
Maleic Acid	2	2
Mercuric		
Mercuric Chloride	X	-
Mercuric Cyanide	2	2
Mercury	1	1
Methane	1	1
Methanol	2	2
Methyl		
Methyl Bromide	2	2
Methyl Ethyl Ketone	2	2
Methyl Isobutyl Ketone	2	2
Methyl Methacrylate	2	2
Methylene Chloride	-	-
Milk	1	1
Mineral Oil	1	2
Muriatic Acid	X	X
Naptha	2	2
Napthalene	1	1
Nickel		
Nickel Chloride	-	-
Nickel Sulfate	2	2
Nitric		
Nitric Acid (100%)	-	-
Nitric Acid (50%)	1	-
Nitric Acid (30%)	1	-
Nitrobenzene	2	2
Oils		
Castor Oil	2	2
Coconut Oil	2	2
Corn Oil	-	2
Cotton Seed Oil	3	2
Fuel Oil	2	2
Linseed Oil	2	2
Mineral Oil	1	2
Silicone Oil	2	2
Vegetable Oil	1	1
Oleic Acid	-	1
Oleum	2	2
Oxalic Acid (sat.)	X	X

	T321	T316
Oxygen	2	2
Palmitic Acid	2	2
Paraffin	2	2
Perchlorethylene	-	-
Petroleum	2	2
Phenol (Carbolic Acid)	-	1
Phosphoric Acid		
Phosphoric Acid (25%-50%)	-	-
Phosphoric Acid (50%-85%)	1	
Photographic Solutions	1	1
Phthalic Anhydride	1	1
Picric Acid	2	2
Plating Solutions		
Brass Plating Solution	-	2
Cadmium Plating Solution	-	2
Chrome 40% Plating Solution	-	2
Copper (Cyanide) Plat. Solution	-	-
Gold Plating Solution	-	1
Iron Plating Solution	-	-
Lead Plating Solution	1	1
Nickel Plating Solution	1	1
Silver Plating Solution	1	1
Tin Plating Solution	X	X
Zinc Plating Solution	-	-
Potassium		
Potassium Acetate	-	-
Potassium Bicarbonate (30%)	1	1
Potassium Carbonate (50%)	1	1
Potassium Chlorate (30%)	2	1
Potassium Chloride (30%)	-	-
Potassium Chromate (30%)	2	2
Potassium Cyanide Sol. (30%)	2	2
Potassium Dichromate (30%)	1	1
Potassium Hydroxide (90%)	X	-
Potassium Nitrate (80%)	2	2
Potassium Permanganate (20%)	2	2
Potassium Sulfate (10%)	-	-
Propane	2	2
Propylene Glycol	2	2
Propylene Oxide	-	-
Pyridine	2	2
Pyrogallic Acid	2	2
Silver Nitrate	2	1
Soap Solutions	2	2
Sodium		
Sodium Acetate	2	2
Sodium Bicarbonate (20%)	1	1
Sodium Bisulfate	-	-
Sodium Bisulfite	-	-
Sodium Borate	2	2
Sodium Perborate (10%)	2	2
Sodium Carbonate	-	-
Sodium Chlorate	-	-
Sodium Chloride	-	-
Sodium Cyanide	-	-
Sodium Dichromate	2	2
Sodium Hydroxide (70%)	2	2
Sodium Hydroxide (50%)	1	-
Sodium Hydroxide (30%)	1	1
Sodium Hypochlorite	X	X
Sodium Metaphosphate	2	2
Sodium Nitrate	-	-
Sodium Perborate (10%)	2	2
Sodium Peroxide (10%)	2	2

	T321	T316
Sodium Silicate	2	2
Sodium Sulfate	-	1
Sodium Sulfide (50%)	-	2
Sodium Thiosulphate	2	2
Stannic Chloride	X	X
Stannous Chloride	X	-
Steam	-	-
Stearic Acid	2	1
Stoddard Solvent	2	2
Sugar Liquors (cane)	2	2
Sugar Liquors (beet)	1	1
Sulfate Liquors	-	2
Sulfite Liquors	2	2
Sulphur Chloride	-	-
Sulphur Dioxide (dry)	-	2
Sulphur Trioxide	-	2
Sulfuric Acid (to 10%)	X	X
Sulfuric Acid (10%-75%)	-	-
Sulfurous Acid	X	-
Tannic Acid	2	2
Tanning Liquors	1	1
Tartaric Acid	1	1
Titanium Tetrachloride	-	-
Toluene	1	1
Tetrahydrofuran	1	2
Tomato Juice	2	2
Trichloroethylene	-	-
Triethanolamine	2	2
Triethylamine	2	2
Trisodium Phosphate	-	-
Turpentine	1	1
Urea	-	-
Urine	1	1
Vinegar	2	2
Water Acid (mine)	-	-
Water (distilled)	2	2
Water (sea)	2	2
Whiskey	1	1
White Liquor (pulp)	2	2
Wine	1	1
Xylene	2	2
Zinc		
Zinc Chloride	X	2
Zinc Nitrate	2	2
Zinc Sulfate (30%)	1	1

Do's & Don'ts

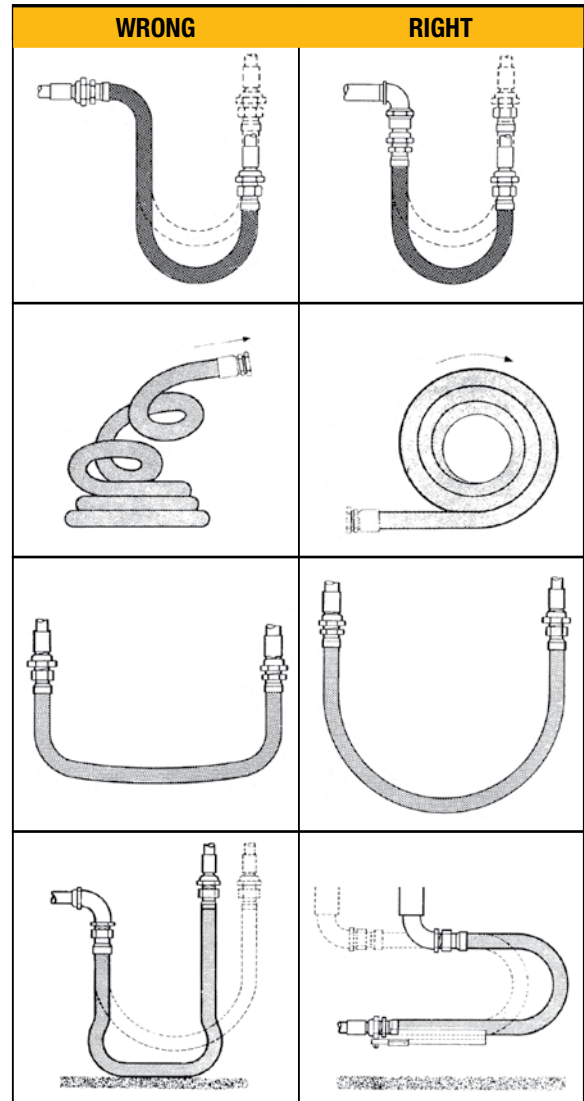
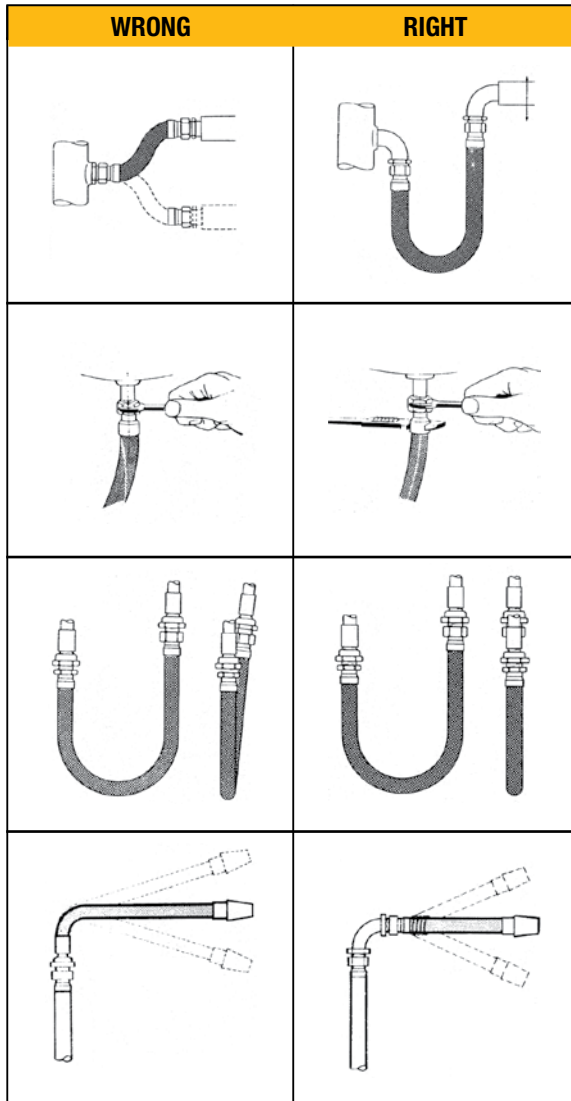

Length Calculations

For the following formulas:

- L = Live Length of Hose (inches)
- T = Travel (inches)
- S = Hose Outside Diameter (see specification sheets)

Verify that the installed radius is less than the stated Minimum Bend Radius for the hose at the required working pressure.

Constant Radius Travelling Loop (A-Loop) Formula: $L = 4R + 1/2T$		Variable Radius Travelling Loop (B-Loop) Formula: $L = 4R + 1.57T$	
A. Vertical Travel 	B. Horizontal Travel 	A. Vertical Travel 	B. Horizontal Travel
Lateral Offset <p>Formula: $L = \sqrt{20R \times T}$ $L_p = \sqrt{L^2 - T^2}$</p> <p>Note 1: When the offset motion occurs on both sides of the hose centerline, use total travel in the formula. Note 2: The offset distance "T" for constant flexing should never exceed 25% of the centerline bend radius.</p>		Angular Deflection <p>Formula: $L = 2S + (\theta/57.3)R$</p>	
Vertical Loop with Movement in Two Directions (Combination Loop) <p>Formula: $L = 4R + 1.57T_1 + (T_2/2)$</p>			

Metal Hose Selection (STAMPED FORM DESCRIPTION)

Parflex Metal hose is available in various constructions to meet the needs of the diverse applications for which it is intended. To ensure proper product selection, the Parker Hannifin Safety Guide for selecting and using hose, tubing, fittings, and related accessories (Parker Publication No. 4400-B1) along with the STAMPED criteria should be considered.

“STAMPED” for Metal Hose

Size

Appropriate Inside Diameter (I.D.) considering flow requirements & pressure drop

- **Reference:** Pressure drop charts (pgs. 15-16)

Temperature

The ambient and minimum/maximum temperature of the media/environment

- All working pressures listed are maximum pressure at 70°F
- **Reference:** Pressure derating charts for working pressure at elevated temperatures (pg. 14)

Application

Abrasion, climate, heat, flexing, and degree of bending are all factors that can impact hose performance and need to be considered during hose selection.

- **Reference:** Do's & Don'ts of Hose Routing (pg. 20)
- **Reference:** Length Calculations for Hose Installation (pg. 21)

Media

The composition of the substance being conveyed

Pressure

The maximum vacuum or pressure of the system, including pressure spikes.

- Derating factors:
 - Temperature - see charts
 - Pressure spikes - Multiple WP by .17
 - Pulsation - Multiply WP by .50
- **Reference:** Pressure drop charts (pg. 15)

Ends

The appropriate end fitting for the application, system and pressure

- **Reference:** Pressure Ratings for End Connections Chart (pg. 16)

Dynamics

High media velocity in metal hose can result in premature hose failure due to resonant vibration.

- **Reference:** Velocity in Metal hoses (pg. 14)

The working pressure of all Parflex Metal Hose assemblies is equal to the pressure rating of the lowest pressure rated component.

Parker Safety Guide

Parker Safety Guide for Selecting and Using Hose, Tubing, Fittings, Connectors, Conductors, Valves and Related Accessories



Parker Safety Guide for Selecting and Using Hose, Tubing, Fittings and Related Accessories Publication No. 4400-B.1 Revised: October 2015, Rev A

WARNING: Failure or improper selection or improper use of hose, tubing, fittings, assemblies, valves, connectors, conductors or related accessories ("Products") can cause death, personal injury and property damage. Possible consequences of failure or improper selection or improper use of these Products include but are not limited to:

- Fittings thrown off at high speed.
- High velocity fluid discharge.
- Explosion or burning of the conveyed fluid.
- Electrocutation from high voltage electric powerlines.
- Contact with suddenly moving or falling objects that
- are controlled by the conveyed fluid.
- Injections by high-pressure fluid discharge.

- Dangerously whipping Hose.
- Tube or pipe burst.
- Weld joint fracture.
- Contact with conveyed fluids that may be hot, cold, toxic or otherwise injurious.
- Sparking or explosion caused by static electricity buildup or other sources of electricity.
- Sparking or explosion while spraying paint or flammable liquids.
- Injuries resulting from inhalation, ingestion or exposure to fluids.

Before selecting or using any of these Products, it is important that you read and follow the instructions below. No product from any division in Parker Fluid Connectors Group is approved for in-flight aerospace applications. For hoses and fittings used in in-flight aerospace applications, please contact Parker Aerospace Group.

1.0 GENERAL INSTRUCTIONS

1.1 Scope: This safety guide provides instructions for selecting and using (including assembling, installing, and maintaining) these Products. For convenience, all rubber and/or thermoplastic products commonly called "hose" or "tubing" are called "Hose" in this safety guide. Metallic tube or pipe are called "tube". All assemblies made with Hose are called "Hose Assemblies". All assemblies made with Tube are called "Tube Assemblies".

All products commonly called "fittings", "couplings" or "adapters" are called "Fittings". Valves are fluid system components that control the passage of fluid. Related accessories are ancillary devices that enhance or monitor performance including crimping, flaring, flanging, presetting, bending, cutting, deburring, swaging machines, sensors, tags, lockout handles, spring guards and associated tooling. This safety guide is a supplement to and is to be used with the specific Parker publications for the specific Hose, Fittings and Related Accessories that are being considered for use. Parker publications are available at www.parker.com. SAE J1273 (www.sae) and ISO 17165-2 (www.ansi.org) also provide recommended practices for hydraulic Hose Assemblies, and should be followed.

1.2 Fail-Safe: Hose, Hose Assemblies, Tube, Tube Assemblies and Fittings can and do fail without warning for many reasons. Design all systems and equipment in a fail-safe mode, so that failure of the Hose, Hose Assembly, Tube, Tube Assembly or Fitting will not endanger persons or property.

1.3 Distribution: Provide a copy of this safety guide to each person responsible for selecting or using Hose, Tube and Fitting products. Do not select or use Parker Hose, Tube or Fittings without thoroughly reading and understanding this safety guide as well as the specific Parker publications for the Products.

1.4 User Responsibility: Due to the wide variety of operating conditions and applications for Hose, Tube and Fittings. Parker does not represent or warrant that any particular Hose, Tube or Fitting is suitable for any specific end use system. This safety guide does not analyze all technical parameters that must be considered in selecting a product. The user, through its own analysis and testing, is solely responsible for:

- Making the final selection of the Products.
- Assuring that the user's requirements are met and that the application presents no health or safety hazards.
- Following the safety guide for Related Accessories and being trained to operate Related Accessories.
- Providing all appropriate health and safety warnings on the equipment on which the Products are used.
- Assuring compliance with all applicable government and industry standards.

1.5 Additional Questions: Call the appropriate Parker technical service department if you have any questions or require any additional information. See the Parker publication for the Products being considered or used, or call 1-800-CPARKER, or go to www.parker.com, for telephone numbers of the appropriate technical service department.

2.0 HOSE, TUBE & FITTINGS SELECTION INSTRUCTIONS

2.1 Electrical Conductivity: Certain applications require that the Hose be nonconductive to prevent electrical current flow. Other applications require the Hose and the Fittings and the Hose/Fitting interface to be sufficiently conductive to drain off static electricity. Extreme care must be exercised when selecting Hose, Tube and Fittings for these or any other applications in which electrical conductivity or nonconductivity is a factor.

The electrical conductivity or nonconductivity of Hose, Tube and Fittings is dependent upon many factors and may be susceptible to change. These factors include but are not limited to the various materials used to make the Hose and the Fittings, Fitting finish (some Fitting finishes are electrically conductive while others are nonconductive), manufacturing methods (including moisture control), how the Fittings contact the Hose, age and amount of deterioration or damage or other changes, moisture content of the Hose at any particular time, and other factors.

The following are considerations for electrically nonconductive and conductive Hose. For other applications consult the individual catalog pages and the appropriate industry or regulatory standards for proper selection.

2.1.1 Electrically Nonconductive Hose: Certain applications require that the Hose be nonconductive to prevent electrical current flow or to maintain electrical isolation. For applications that require Hose to be electrically nonconductive, including but not limited to applications near high voltage electric lines, only special nonconductive Hose can be used. The manufacturer of the equipment in which the nonconductive Hose is to be used must be consulted to be certain that the Hose, Tube and Fittings that are selected are proper for the application. Do not use any Parker Hose or Fittings for any such application requiring nonconductive Hose, including but not limited to applications near high voltage electric lines or dense magnetic fields, unless (i) the application is expressly approved in the Parker technical publication for the product, (ii) the Hose is marked "nonconductive", and (iii) the manufacturer of the equipment on which the Hose is to be used specifically approves the particular Parker Hose, Tube and Fittings for such use.

2.1.2 Electrically Conductive Hose: Parker manufactures special Hose for certain applications that require electrically conductive Hose. Parker manufactures special Hose for conveying paint in airless paint spraying applications. This Hose is labeled "Electrically Conductive Airless Paint Spray Hose" on its layline and packaging. This Hose must be properly connected to the appropriate Parker Fittings and properly grounded in order to dissipate dangerous static charge buildup, which occurs in all airless paint spraying applications. Do not use any other Hose for airless paint spraying, even if electrically conductive. Use of any other Hose or failure to properly connect the Hose can cause a fire or an explosion resulting in death, personal injury, and property damage. All hoses that convey fuels must be grounded.

Parker manufactures a special Hose for certain compressed natural gas ("CNG") applications where static electricity buildup may occur. Parker CNG Hose assemblies comply with the requirements of ANSI/IAS NGV 4.2:CSA 12.52, "Hoses for Natural Gas Vehicles and Dispensing Systems" (www.ansi.org). This Hose is labeled "Electrically Conductive for CNG Use"

on its layline and packaging. This Hose must be properly connected to the appropriate Parker Fittings and properly grounded in order to dissipate dangerous static charge buildup, which occurs in, for example, high velocity CNG dispensing or transfer. Do not use any other Hose for CNG applications where static charge buildup may occur, even if electrically conductive. Use of other Hoses in CNG applications or failure to properly connect or ground this Hose can cause a fire or an explosion resulting in death, personal injury, and property damage. Care must also be taken to protect against CNG permeation through the Hose wall. See section 2.6, Permeation, for more information. Parker CNG Hose is intended for dispenser and vehicle use within the specified temperature range. Parker CNG Hose should not be used in confined spaces or unventilated areas or areas exceeding the specified temperature range. Final assemblies must be tested for leaks. CNG Hose Assemblies should be tested on a monthly basis for conductivity per ANSI/IAS NGV 4.2; CSA 12.52.

Parker manufactures special Hose for aerospace in-flight applications. Aerospace in-flight applications employing Hose to transmit fuel, lubricating fluids and hydraulic fluids require a special Hose with a conductive inner tube. This Hose for in-flight applications is available only from Parker's Stratoflex Products Division. Do not use any other Parker Hose for in-flight applications, even if electrically conductive. Use of other Hoses for in-flight applications or failure to properly connect or ground this Hose can cause a fire or an explosion resulting in death, personal injury and property damage. These Hose assemblies for in-flight applications must meet all applicable aerospace industry, aircraft engine and aircraft requirements.

2.2 Pressure: Hose, Tube and Fitting selection must be made so that the published maximum working pressure of the Hose, Tube and Fittings are equal to or greater than the maximum system pressure. The maximum working pressure of a Hose, or Tube Assembly is the lower of the respective published maximum working pressures of the Hose, Tube and the Fittings used. Surge pressures or peak transient pressures in the system must be below the published maximum working pressure for the Hose, Tube and Fitting. Surge pressures and peak pressures can usually only be determined by sensitive electrical instrumentation that measures and indicates pressures at millisecond intervals. Mechanical pressure gauges indicate only average pressures and cannot be used to determine surge pressures or peak transient pressures. Published burst pressure ratings for Hose is for manufacturing test purposes only and is no indication that the Product can be used in applications at the burst pressure or otherwise above the published maximum recommended working pressure.

2.3 Suction: Hoses used for suction applications must be selected to insure that the Hose will withstand the vacuum and pressure of the system. Improperly selected Hose may collapse in suction application.

2.4 Temperature: Be certain that fluid and ambient temperatures, both steady and transient, do not exceed the limitations of the Hose, Tube, Fitting and Seals. Temperatures below and above the recommended limit can degrade Hose, Tube, Fittings and Seals to a point where a failure may occur and release fluid. Tube and Fittings performances are normally degraded at elevated temperature. Material compatibility can also change at temperatures outside of the rated range. Properly insulate and protect the Hose Assembly when routing near hot objects (e.g. manifolds). Do not use any Hose in any application where failure of the Hose could result in the conveyed fluids (or vapors or mist from the conveyed fluids) contacting any open flame, molten metal, or other potential fire ignition source that could cause burning or explosion of the conveyed fluids or vapors.

2.5 Fluid Compatibility: Hose, and Tube Assembly selection must assure compatibility of the Hose tube, cover, reinforcement, Tube, Plating and Seals with the fluid media used. See the fluid compatibility chart in the Parker publication for the product being considered or used. This information is offered only as a guide. Actual service life can only be determined by the end user by testing under all extreme conditions and other analysis.

Hose, and Tube that is chemically compatible with a particular fluid must be assembled using Fittings and adapters containing likewise compatible seals. Flange or flare processes can change Tube material properties that may not be compatible with certain requirements such as NACE

2.6 Permeation: Permeation (that is, seepage through the Hose or Seal) will occur from inside the Hose or Fitting to outside when Hose or Fitting is used with gases, liquid and gas fuels, and refrigerants (including but not limited to such materials as helium, diesel fuel, gasoline, natural gas, or LPG). This permeation may result in high concentrations of vapors which are potentially flammable, explosive, or toxic, and in loss of fluid. Dangerous explosions, fires, and other hazards can result when using the wrong Hose for such applications. The system designer must take into account the fact that this permeation will take place and

must not use Hose or Fitting if this permeation could be hazardous. The system designer must take into account all legal, government, insurance, or any other special regulations which govern the use of fuels and refrigerants. Never use a Hose or Fitting even though the fluid compatibility is acceptable without considering the potential hazardous effects that can result from permeation through the Hose or Tube Assembly. Permeation of moisture from outside the Hose or Fitting to inside the Hose or Fitting will also occur in Hose or Tube assemblies, regardless of internal pressure. If this moisture permeation would have detrimental effects (particularly, but not limited to refrigeration and air conditioning systems), incorporation of sufficient drying capacity in the system or other appropriate system safeguards should be selected and used. The sudden pressure release of highly pressurized gas could also result in Explosive Decompression failure of permeated Seals and Hoses.

2.7 Size: Transmission of power by means of pressurized fluid varies with pressure and rate of flow. The size of the components must be adequate to keep pressure losses to a minimum and avoid damage due to heat generation or excessive fluid velocity.

2.8 Routing: Attention must be given to optimum routing to minimize inherent problems (kinking or flow restriction due to Hose collapse, twisting of the Hose, proximity to hot objects or heat sources). For additional routing recommendations see SAE J1273 and ISO 17165-2. Hose Assemblies have a finite life and should be installed in a manner that allows for ease of inspection and future replacement. Hose because of its relative short life, should not be used in residential and commercial buildings inside of inaccessible walls or floors, unless specifically allowed in the product literature. Always review all product literature for proper installation and routing instructions.

2.9 Environment: Care must be taken to insure that the Hose, Tube and Fittings are either compatible with or protected from the environment (that is, surrounding conditions) to which they are exposed. Environmental conditions including but not limited to ultraviolet radiation, sunlight, heat, ozone, moisture, water, salt water, chemicals and air pollutants can cause degradation and premature failure.

2.10 Mechanical Loads: External forces can significantly reduce Hose, Tube and Fitting life or cause failure. Mechanical loads which must be considered include excessive flexing, twist, kinking, tensile or side loads, bend radius, and vibration. Use of swivel type Fittings or adapters may be required to insure no twist is put into the Hose. Use of proper Hose or Tube clamps may also be required to reduce external mechanical loads. Unusual applications may require special testing prior to Hose selection.

2.11 Physical Damage: Care must be taken to protect Hose from wear, snagging, kinking, bending smaller than minimum bend radius and cutting, any of which can cause premature Hose failure. Any Hose that has been kinked or bent to a radius smaller than the minimum bend radius, and any Hose that has been cut or is cracked or is otherwise damaged should be removed and discarded. Fittings with damages such as scratches on sealing surfaces and deformation should be replaced.

2.12 Proper End Fitting: See instructions 3.2 through 3.5. These recommendations may be substantiated by testing to industry standards such as SAE J517 for hydraulic applications, or MIL-A-5070, AS1339, or AS3517 for Hoses from Parker's Stratoflex Products Division for aerospace applications.

2.13 Length: When determining the proper Hose or Tube length of an assembly, be aware of Hose length change due to pressure, Tube length change due to thermal expansion or contraction, and Hose or Tube and machine tolerances and movement must be considered. When routing short hose assemblies, it is recommended that the minimum free hose length is always used. Consult the hose manufacturer for their minimum free hose length recommendations. Hose assemblies should be installed in such a way that any motion or flexing occurs within the same plane.

2.14 Specifications and Standards: When selecting Hose, Tube and Fittings, government, industry, and Parker specifications and recommendations must be reviewed and followed as applicable.

2.15 Hose Cleanliness: Hose and Tube components may vary in cleanliness levels. Care must be taken to insure that the Hose and Tube Assembly selected has an adequate level of cleanliness for the application.

2.16 Fire Resistant Fluids: Some fire resistant fluids that are to be conveyed by Hose or Tube require use of the same type of Hose or Tube as used with petroleum base fluids. Some such fluids require a special Hose, Tube, Fitting and Seal, while a few fluids will not work with any Hose at all. See instructions 2.5 and 1.5. The wrong Hose, Tube, Fitting or Seal may fail after a very short service. In addition, all liquids but pure water may burn fiercely under certain conditions, and even pure water leakage may be hazardous.

2.17 **Radiant Heat:** Hose and Seals can be heated to destruction without contact by such nearby items as hot manifolds or molten metal. The same heat source may then initiate a fire. This can occur despite the presence of cool air around the Hose or Seal. Performance of Tube and Fitting subjected to the heat could be degraded.

2.18 **Welding or Brazing:** When using a torch or arc welder in close proximity to hydraulic lines, the hydraulic lines should be removed or shielded with appropriate fire resistant materials. Flame or weld spatter could burn through the Hose or Seal and possibly ignite escaping fluid resulting in a catastrophic failure. Heating of plated parts, including Hose Fittings and adapters, above 450°F (232°C) such as during welding, brazing or soldering may emit deadly gases. Any elastomer seal on fittings shall be removed prior to welding or brazing, any metallic surfaces shall be protected after brazing or welding when necessary. Welding and brazing filler material shall be compatible with the Tube and Fitting that are joined.

2.19 **Atomic Radiation:** Atomic radiation affects all materials used in Hose and Tube assemblies. Since the long-term effects may be unknown, do not expose Hose or Tube assemblies to atomic radiation. Nuclear applications may require special Tube and Fittings.

2.20 **Aerospace Applications:** The only Hose, Tube and Fittings that may be used for in-flight aerospace applications are those available from Parker's Stratoflex Products Division. Do not use any other Hose or Fittings for in-flight applications. Do not use any Hose or Fittings from Parker's Stratoflex Products Division with any other Hose or Fittings, unless expressly approved in writing by the engineering manager or chief engineer of Stratoflex Products Division and verified by the user's own testing and inspection to aerospace industry standards.

2.21 **Unlocking Couplings:** Ball locking couplings or other Fittings with quick disconnect ability can unintentionally disconnect if they are dragged over obstructions, or if the sleeve or other disconnect member, is bumped or moved enough to cause disconnect. Threaded Fittings should be considered where there is a potential for accidental uncoupling.

3.0 HOSE AND FITTINGS ASSEMBLY AND INSTALLATION INSTRUCTIONS

3.1 **Component Inspection:** Prior to assembly, a careful examination of the Hose and Fittings must be performed. All components must be checked for correct style, size, catalog number, and length. The Hose must be examined for cleanliness, obstructions, blisters, cover looseness, kinks, cracks, cuts or any other visible defects. Inspect the Fitting and sealing surfaces for burrs, nicks, corrosion or other imperfections. Do NOT use any component that displays any signs of nonconformance.

3.2 **Hose and Fitting Assembly:** Do not assemble a Parker Fitting on a Parker Hose that is not specifically listed by Parker for that Fitting, unless authorized in writing by the engineering manager or chief engineer of the appropriate Parker division. Do not assemble a Parker Fitting on another manufacturer's Hose or a Parker Hose on another manufacturer's Fitting unless (i) the engineering manager or chief engineer of the appropriate Parker division approves the Assembly in writing or that combination is expressly approved in the appropriate Parker literature for the specific Parker product, and (ii) the user verifies the Assembly and the application through analysis and testing. For Parker Hose that does not specify a Parker Fitting, the user is solely responsible for the selection of the proper Fitting and Hose Assembly procedures. See instruction 1.4.

To prevent the possibility of problems such as leakage at the Fitting or system contamination, it is important to completely remove all debris from the cutting operation before installation of the Fittings. The Parker published instructions must be followed for assembling the Fittings on the Hose. These instructions are provided in the Parker Fitting catalog for the specific Parker Fitting being used, or by calling 1-800-CPARKER, or at www.parker.com.

3.3 **Related Accessories:** Do not crimp or swage any Parker Hose or Fitting with anything but the listed swage or crimp machine and dies in accordance with Parker published instructions. Do not crimp or swage another manufacturer's Fitting with a Parker crimp or swage die unless authorized in writing by the engineering manager or chief engineer of the appropriate Parker division.

3.4 **Parts:** Do not use any Parker Fitting part (including but not limited to socket, shell, nipple, or insert) except with the correct Parker mating parts, in accordance with Parker published instructions, unless authorized in writing by the engineering manager or chief engineer of the appropriate Parker division.

3.5 **Field Attachable/Permanent:** Do not reuse any field attachable Hose Fitting that has blown or pulled off a Hose. Do not reuse a Parker permanent Hose Fitting (crimped or swaged) or any part thereof. Complete

Hose Assemblies may only be reused after proper inspection under section 4.0. Do not assemble Fittings to any previously used hydraulic Hose that was in service, for use in a fluid power application.

3.6 **Pre-Installation Inspection:** Prior to installation, a careful examination of the Hose Assembly must be performed. Inspect the Hose Assembly for any damage or defects. DO NOT use any Hose Assembly that displays any signs of nonconformance.

3.7 **Minimum Bend Radius:** Installation of a Hose at less than the minimum listed bend radius may significantly reduce the Hose life. Particular attention must be given to preclude sharp bending at the Hose to Fitting juncture. Any bending during installation at less than the minimum bend radius must be avoided. If any Hose is kinked during installation, the Hose must be discarded.

3.8 **Twist Angle and Orientation:** Hose Assembly installation must be such that relative motion of machine components does not produce twisting.

3.9 **Securement:** In many applications, it may be necessary to restrain, protect, or guide the Hose to protect it from damage by unnecessary flexing, pressure surges, and contact with other mechanical components. Care must be taken to insure such restraints do not introduce additional stress or wear points.

3.10 **Proper Connection of Ports:** Proper physical installation of the Hose Assembly requires a correctly installed port connection insuring that no twist or torque is transferred to the Hose when the Fittings are being tightened or otherwise during use.

3.11 **External Damage:** Proper installation is not complete without insuring that tensile loads, side loads, kinking, flattening, potential abrasion, thread damage or damage to sealing surfaces are corrected or eliminated. See instruction 2.10.

3.12 **System Checkout:** All air entrapment must be eliminated and the system pressurized to the maximum system pressure (at or below the Hose maximum working pressure) and checked for proper function and freedom from leaks. Personnel must stay out of potential hazardous areas while testing and using.

3.13 **Routing:** The Hose Assembly should be routed in such a manner so if a failure does occur, the escaping media will not cause personal injury or property damage. In addition, if fluid media comes in contact with hot surfaces, open flame or sparks, a fire or explosion may occur. See section 2.4.

3.14 **Ground Fault Equipment Protection Devices (GFEPDs):** WARNING! Fire and Shock Hazard. To minimize the danger of fire if the heating cable of a Multitube bundle is damaged or improperly installed, use a Ground Fault Equipment Protection Device. Electrical fault currents may be insufficient to trip a conventional circuit breaker.

For ground fault protection, the IEEE 515: (www.ansi.org) standard for heating cables recommends the use of GFEPDs with a nominal 30 milliamperes trip level for "piping systems in classified areas, those areas requiring a high degree of maintenance, or which may be exposed to physical abuse or corrosive atmospheres".

4.0 TUBE AND FITTINGS ASSEMBLY AND INSTALLATION INSTRUCTIONS

4.1 **Component Inspection:** Prior to assembly, a careful examination of the Tube and Fittings must be performed. All components must be checked for correct style, size, material, seal, and length. Inspect the Fitting and sealing surfaces for burrs, nicks, corrosion, missing seal or other imperfections. Do NOT use any component that displays any signs of nonconformance.

4.2 **Tube and Fitting Assembly:** Do not assemble a Parker Fitting with a Tube that is not specifically listed by Parker for that Fitting, unless authorized in writing by the engineering manager or chief engineer of the appropriate Parker division. The Tube must meet the requirements specified to the Fitting. The Parker published instructions must be followed for assembling the Fittings to a Tube. These instructions are provided in the Parker Fitting catalog for the specific Parker Fitting being used, or by calling 1-800-CPARKER, or at www.parker.com.

4.3 **Related Accessories:** Do not preset or flange Parker Fitting components using another manufacturer's equipment or procedures unless authorized in writing by the engineering manager or chief engineer of the appropriate Parker division. Tube, Fitting component and tooling must be checked for correct style, size and material. Operation and maintenance of Related Accessories must be in accordance with the operation manual for the designated Accessory.

4.4 **Securement:** In many applications, it may be necessary to restrain, protect, or guide the Tube to protect it from damage by unnecessary flexing, pressure surges, vibration, and contact with other mechanical components. Care must be taken to insure such restraints do not introduce additional stress or wear points.

4.5 Proper Connection of Ports: Proper physical installation of the Tube Assembly requires a correctly installed port connection insuring that no torque is transferred to the Tube when the Fittings are being tightened or otherwise during use.

4.6 External Damage: Proper installation is not complete without insuring that tensile loads, side loads, flattening, potential abrasion, thread damage or damage to sealing surfaces are corrected or eliminated. See instruction 2.10.

4.7 System Checkout: All air entrapment must be eliminated and the system pressurized to the maximum system pressure (at or below the Tube Assembly maximum working pressure) and checked for proper function and freedom from leaks. Personnel must stay out of potential hazardous areas while testing and using.

4.8 Routing: The Tube Assembly should be routed in such a manner so if a failure does occur, the escaping media will not cause personal injury or property damage. In addition, if fluid media comes in contact with hot surfaces, open flame or sparks, a fire or explosion may occur. See section 2.4.

5.0 HOSE AND FITTING MAINTENANCE AND REPLACEMENT INSTRUCTIONS

5.1 Even with proper selection and installation, Hose life may be significantly reduced without a continuing maintenance program. The severity of the application, risk potential from a possible Hose failure, and experience with any Hose failures in the application or in similar applications should determine the frequency of the inspection and the replacement for the Products so that Products are replaced before any failure occurs. Certain products require maintenance and inspection per industry requirements. Failure to adhere to these requirements may lead to premature failure. A maintenance program must be established and followed by the user and, at minimum, must include instructions 5.2 through 5.7

5.2 Visual Inspection Hose/Fitting: Any of the following conditions require immediate shut down and replacement of the Hose Assembly:

- Fitting slippage on Hose;
- Damaged, cracked, cut or abraded cover (any reinforcement exposed);
- Hard, stiff, heat cracked, or charred Hose;
- Cracked, damaged, or badly corroded Fittings;
- Leaks at Fitting or in Hose;
- Kinked, crushed, flattened or twisted Hose; and
- Blistered, soft, degraded, or loose cover.

5.3 Visual Inspection All Other: The following items must be tightened, repaired, corrected or replaced as required:

- Leaking port conditions;
- Excess dirt buildup;/
- Worn clamps, guards or shields; and
- System fluid level, fluid type, and any air entrapment.

5.4 Functional Test: Operate the system at maximum operating pressure and check for possible malfunctions and leaks. Personnel must avoid potential hazardous areas while testing and using the system. See section 2.2.

5.5 Replacement Intervals: Hose assemblies and elastomeric seals used on Hose Fittings and adapters will eventually age, harden, wear and deteriorate under thermal cycling and compression set. Hose Assemblies and elastomeric seals should be inspected and replaced at specific replacement intervals, based on previous service life, government or industry recommendations, or when failures could result in unacceptable downtime, damage, or injury risk. See section 1.2. Hose and Fittings may be subjected to internal mechanical and/or chemical wear from the conveying fluid and may fail without warning. The user must determine the product life under such circumstances by testing. Also see section 2.5.

5.6 Hose Inspection and Failure: Hydraulic power is accomplished by utilizing high pressure fluids to transfer energy and do work. Hoses, Fittings and Hose Assemblies all contribute to this by transmitting fluids at high pressures. Fluids under pressure can be dangerous and potentially lethal and, therefore, extreme caution must be exercised when working with fluids under pressure and handling the Hoses transporting the fluids. From time to time, Hose Assemblies will fail if they are not replaced at proper time intervals. Usually these failures are the result of some form of misapplication, abuse, wear or failure to perform proper maintenance. When Hoses fail, generally the high pressure fluids inside escape in a stream which may or may not be visible to the user. Under no circumstances should the user attempt to locate the leak by "feeling" with their hands or any other part of their body. High pressure fluids can and will penetrate the skin and cause severe tissue damage and

possibly loss of limb. Even seemingly minor hydraulic fluid injection injuries must be treated immediately by a physician with knowledge of the tissue damaging properties of hydraulic fluid.

If a Hose failure occurs, immediately shut down the equipment and leave the area until pressure has been completely released from the Hose Assembly. Simply shutting down the hydraulic pump may or may not eliminate the pressure in the Hose Assembly. Many times check valves, etc., are employed in a system and can cause pressure to remain in a Hose Assembly even when pumps or equipment are not operating. Tiny holes in the Hose, commonly known as pinholes, can eject small, dangerously powerful but hard to see streams of hydraulic fluid. It may take several minutes or even hours for the pressure to be relieved so that the Hose Assembly may be examined safely.

Once the pressure has been reduced to zero, the Hose Assembly may be taken off the equipment and examined. It must always be replaced if a failure has occurred. Never attempt to patch or repair a Hose Assembly that has failed. Consult the nearest Parker distributor or the appropriate Parker division for Hose Assembly replacement information. .

Never touch or examine a failed Hose Assembly unless it is obvious that the Hose no longer contains fluid under pressure. The high pressure fluid is extremely dangerous and can cause serious and potentially fatal injury.

5.7 Elastomeric seals: Elastomeric seals will eventually age, harden, wear and deteriorate under thermal cycling and compression set. Elastomeric seals should be inspected and replaced.

5.8 Refrigerant gases: Special care should be taken when working with refrigeration systems. Sudden escape of refrigerant gases can cause blindness if the escaping gases contact the eye and can cause freezing or other severe injuries if it contacts any other portion of the body.

5.9 Compressed natural gas (CNG): Parker CNG Hose Assemblies should be tested after installation and before use, and at least on a monthly basis per instructions provided on the Hose Assembly tag. The recommended procedure is to pressurize the Hose and check for leaks and to visually inspect the Hose for damage and to perform an electrical resistance test.

Caution: Matches, candles, open flame or other sources of ignition shall not be used for Hose inspection. Leak check solutions should be rinsed off after use.

6.0 HOSE STORAGE

6.1 Age Control: Hose and Hose Assemblies must be stored in a manner that facilitates age control and first-in and first-out usage based on manufacturing date of the Hose and Hose Assemblies. Unless otherwise specified by the manufacturer or defined by local laws and regulations:

6.1.1 The shelf life of rubber hose in bulk form or hose made from two or more materials is 28 quarters (7 years) from the date of manufacture, with an extension of 12 quarters (3 years), if stored in accordance with ISO 2230;

6.1.2 The shelf life of thermoplastic and polytetrafluoroethylene hose is considered to be unlimited;

6.1.3 Hose assemblies that pass visual inspection and proof test shall not be stored for longer than 2 years.

6.1.4 Storage: Stored Hose and Hose Assemblies must not be subjected to damage that could reduce their expected service life and must be placed in a cool, dark and dry area with the ends capped. Stored Hose and Hose Assemblies must not be exposed to temperature extremes, ozone, oils, corrosive liquids or fumes, solvents, high humidity, rodents, insects, ultraviolet light, electromagnetic fields or radioactive materials.

**PARKER-HANNIFIN CORPORATION
OFFER OF SALE**

1. **Definitions.** As used herein, the following terms have the meanings indicated.

Buyer:	means any customer receiving a Quote for Products from Seller.
Goods:	means any tangible part, system or component to be supplied by the Seller.
Products:	means the Goods, Services and/or Software as described in a Quote provided by the Seller.
Quote:	means the offer or proposal made by Seller to Buyer for the supply of Products.
Seller:	means Parker-Hannifin Corporation, including all divisions and businesses thereof.
Services:	means any services to be supplied by the Seller.
Software:	means any software related to the Products, whether embedded or separately downloaded.
Terms:	means the terms and conditions of this Offer of Sale or any newer version of the same as published by Seller electronically at www.parker.com/saleterms .

2. **Terms.** All sales of Products by Seller are contingent upon, and will be governed by, these Terms and, these Terms are incorporated into any Quote provided by Seller to any Buyer. Buyer's order for any Products whether communicated to Seller verbally, in writing, by electronic data interface or other electronic commerce, shall constitute acceptance of these Terms. Seller objects to any contrary or additional terms or conditions of Buyer. Reference in Seller's order acknowledgement to Buyer's purchase order or purchase order number shall in no way constitute an acceptance of any of Buyer's terms of purchase. No modification to these Terms will be binding on Seller unless agreed to in writing and signed by an authorized representative of Seller.
3. **Price; Payment.** The Products set forth in Seller's Quote are offered for sale at the prices indicated in Seller's Quote. Unless otherwise specifically stated in Seller's Quote, prices are valid for thirty (30) days and do not include any sales, use, or other taxes or duties. Seller reserves the right to modify prices at any time to adjust for any raw material price fluctuations. Unless otherwise specified by Seller, all prices are F.C.A. Seller's facility (INCOTERMS 2010). All sales are contingent upon credit approval and payment for all purchases is due thirty (30) days from the date of invoice (or such date as may be specified in the Quote). Unpaid invoices beyond the specified payment date incur interest at the rate of 1.5% per month or the maximum allowable rate under applicable law.
4. **Shipment; Delivery; Title and Risk of Loss.** All delivery dates are approximate. Seller is not responsible for damages resulting from any delay. Regardless of the manner of shipment, delivery occurs and title and risk of loss or damage pass to Buyer, upon placement of the Products with the shipment carrier at Seller's facility. Unless otherwise agreed, Seller may exercise its judgment in choosing the carrier and means of delivery. No deferment of shipment at Buyers' request beyond the respective indicated shipping date will be made except on terms that will indemnify, defend and hold Seller harmless against all loss and additional expense. Buyer shall be responsible for any additional shipping charges incurred by Seller due to Buyer's acts or omissions.
5. **Warranty.** The warranty related to the Products is as follows: (i) Goods are warranted against defects in material or workmanship for a period of twelve (12) months from the date of delivery or 2,000 hours of use, whichever occurs first; (ii) Services shall be performed in accordance with generally accepted practices and using the degree of care and skill that is ordinarily exercised and customary in the field to which the Services pertain and are warranted for a period of six (6) months from the completion of the Services by Seller; and (iii) Software is only warranted to perform in accordance with applicable specifications provided by Seller to Buyer for ninety (90) days from the date of delivery or, when downloaded by a Buyer or end-user, from the date of the initial download. All prices are based upon the exclusive limited warranty stated above, and upon the following disclaimer:

DISCLAIMER OF WARRANTY: THIS WARRANTY IS THE SOLE AND ENTIRE WARRANTY PERTAINING TO PRODUCTS. SELLER DISCLAIMS ALL OTHER WARRANTIES, EXPRESS AND IMPLIED, INCLUDING DESIGN, NONINFRINGEMENT, MERCHANTABILITY, AND FITNESS FOR A PARTICULAR PURPOSE. SELLER DOES NOT WARRANT THAT THE SOFTWARE IS ERROR-FREE OR FAULT-TOLERANT, OR THAT

BUYER'S USE THEREOF WILL BE SECURE OR UNINTERRUPTED. BUYER AGREES AND ACKNOWLEDGES THAT UNLESS OTHERWISE AUTHORIZED IN WRITING BY SELLER THE SOFTWARE SHALL NOT BE USED IN CONNECTION WITH HAZARDOUS OR HIGH RISK ACTIVITIES OR ENVIRONMENTS. EXCEPT AS EXPRESSLY STATED HEREIN, ALL PRODUCTS ARE PROVIDED "AS IS".

6. **Claims; Commencement of Actions.** Buyer shall promptly inspect all Products upon receipt. No claims for shortages will be allowed unless reported to the Seller within ten (10) days of delivery. Buyer shall notify Seller of any alleged breach of warranty within thirty (30) days after the date the non-conformance is or should have been discovered by Buyer. Any claim or action against Seller based upon breach of contract or any other theory, including tort, negligence, or otherwise must be commenced within twelve (12) months from the date of the alleged breach or other alleged event, without regard to the date of discovery.
7. **LIMITATION OF LIABILITY.** IN THE EVENT OF A BREACH OF WARRANTY, SELLER WILL, AT ITS OPTION, REPAIR OR REPLACE THE NON-CONFORMING PRODUCT, RE-PERFORM THE SERVICES, OR REFUND THE PURCHASE PRICE PAID WITHIN A REASONABLE PERIOD OF TIME. **IN NO EVENT IS SELLER LIABLE FOR ANY SPECIAL, INDIRECT, INCIDENTAL OR CONSEQUENTIAL DAMAGES ARISING OUT OF, OR AS THE RESULT OF, THE SALE, DELIVERY, NON- DELIVERY, SERVICING, NON-COMPLETION OF SERVICES, USE, LOSS OF USE OF, OR INABILITY TO USE THE PRODUCTS OR ANY PART THEREOF, LOSS OF DATA, IDENTITY, PRIVACY, OR CONFIDENTIALITY, OR FOR ANY CHARGES OR EXPENSES OF ANY NATURE INCURRED WITHOUT SELLER'S WRITTEN CONSENT, WHETHER BASED IN CONTRACT, TORT OR OTHER LEGAL THEORY. IN NO EVENT SHALL SELLER'S LIABILITY UNDER ANY CLAIM MADE BY BUYER EXCEED THE PURCHASE PRICE PAID FOR THE PRODUCTS.**
8. **Loss to Buyer's Property.** Any designs, tools, patterns, materials, drawings, confidential information or equipment furnished by Buyer or any other items which are or become Buyer's property, will be considered obsolete and may be destroyed by Seller after two (2) consecutive years have elapsed without Buyer ordering the Products manufactured using such property. Seller shall not be responsible for any loss or damage to such property while it is in Seller's possession or control.
9. **Special Tooling.** Special Tooling includes but is not limited to tooling, jigs, fixtures and associated manufacturing equipment acquired or necessary to manufacture Products. A tooling charge may be imposed for any Special Tooling. Such Special Tooling shall be and remain Seller's property notwithstanding payment of any charges by Buyer. In no event will Buyer acquire any interest in Special Tooling belonging to Seller that is utilized in the manufacture of the Products, even if such Special Tooling has been specially converted or adapted for such manufacture and notwithstanding any charges paid by Buyer. Unless otherwise agreed, Seller has the right to alter, discard or otherwise dispose of any Special Tooling or other property in its sole discretion at any time.
10. **Security Interest.** To secure payment of all sums due, Seller retains a security interest in all Products delivered to Buyer and, Buyer's acceptance of these Terms is deemed to be a Security Agreement under the Uniform Commercial Code. Buyer authorizes Seller as its attorney to execute and file on Buyer's behalf all documents Seller deems necessary to perfect its security interest.
11. **User Responsibility.** The Buyer through its own analysis and testing, is solely responsible for making the final selection of the Products and assuring that all performance, endurance, maintenance, safety and warning requirements of the application of the Products are met. The Buyer must analyze all aspects of the application and follow applicable industry standards, specifications, and other technical information provided with the Product. If Seller provides Product options based upon data or specifications provided by the Buyer, the Buyer is responsible for determining that such data and specifications are suitable and sufficient for all applications and reasonably foreseeable uses of the Products. In the event the Buyer is not the end-user, Buyer will ensure such end-user complies with this paragraph.
12. **Use of Products, Indemnity by Buyer.** Buyer shall comply with all instructions, guides and specifications provided by Seller with the Products. Unauthorized Uses. If Buyer uses or resells the Products for any uses prohibited in Seller's instructions, guides or specifications, or Buyer otherwise fails to comply with Seller's instructions, guides and specifications, Buyer acknowledges that any such use, resale, or non-

Continued on next page

compliance is at Buyer's sole risk. Buyer shall indemnify, defend, and hold Seller harmless from any losses, claims, liabilities, damages, lawsuits, judgments and costs (including attorney fees and defense costs), whether for personal injury, property damage, intellectual property infringement or any other claim, brought by or incurred by Buyer, Buyer's employees, or any other person, arising out of: (a) improper selection, application, design, specification or other misuse of Products provided by Seller; (b) any act or omission, negligent or otherwise, of Buyer; (c) Seller's use of patterns, tooling, equipment, plans, drawings, designs or specifications or other information or things furnished by Buyer; (d) damage to the Products from an external cause, repair or attempted repair by anyone other than Seller, failure to follow instructions, guides and specifications provided by Seller, use with goods not provided by Seller, or opening, modifying, deconstructing or tampering with the Products for any reason; or (e) Buyer's failure to comply with these Terms. Seller shall not indemnify Buyer under any circumstance except as otherwise provided in these Terms.

- 13. Cancellations and Changes.** Buyer may not cancel or modify any order for any reason, except with Seller's written consent and upon terms that will indemnify, defend and hold Seller harmless against all direct, incidental and consequential loss or damage. Seller, at any time, may change Product features, specifications, designs and availability.
- 14. Limitation on Assignment.** Buyer may not assign its rights or obligations without the prior written consent of Seller.
- 15. Force Majeure.** Seller does not assume the risk and is not liable for delay or failure to perform any of Seller's obligations by reason of events or circumstances beyond its reasonable control ("Events of Force Majeure"). Events of Force Majeure shall include without limitation: accidents, strikes or labor disputes, acts of any government or government agency, acts of nature, delays or failures in delivery from carriers or suppliers, shortages of materials, or any other cause beyond Seller's reasonable control.
- 16. Waiver and Severability.** Failure to enforce any provision of these Terms will not invalidate that provision; nor will any such failure prejudice Seller's right to enforce that provision in the future. Invalidation of any provision of these Terms by legislation or other rule of law shall not invalidate any other provision herein and, the remaining provisions will remain in full force and effect.
- 17. Termination.** Seller may terminate any agreement governed by or arising from these Terms for any reason and at any time by giving Buyer thirty (30) days prior written notice. Seller may immediately terminate, in writing, if Buyer: (a) breaches any provision of these Terms (b) appoints a trustee, receiver or custodian for all or any part of Buyer's property (c) files a petition for relief in bankruptcy on its own behalf, or one if filed by a third party (d) makes an assignment for the benefit of creditors; or (e) dissolves its business or liquidates all or a majority of its assets.
- 18. Ownership of Software.** Seller retains ownership of all Software supplied to Buyer hereunder. In no event shall Buyer obtain any greater right in and to the Software than a right in the nature of a license limited to the use thereof and subject to compliance with any other terms provided with the Software.
- 19. Indemnity for Infringement of Intellectual Property Rights.** Seller is not liable for infringement of any patents, trademarks, copyrights, trade dress, trade secrets or similar rights ("Intellectual Property Rights") except as provided in this Section. Seller will defend at its expense and will pay the cost of any settlement or damages awarded in an action brought against Buyer based on a third party claim that one or more of the Products sold hereunder infringes the Intellectual Property Rights of a third party in the country of delivery of the Products by the Seller to the Buyer. Seller's obligation to defend and indemnify Buyer is contingent on Buyer notifying Seller within ten (10) days after Buyer becomes aware of any such claim, and Seller having sole control over the defense of the claim including all negotiations for settlement or compromise. If one or more Products sold hereunder is subject to such a claim, Seller may, at its sole expense and option, procure for Buyer the right to continue using the Products, replace or modify the Products so as to render them non-infringing, or offer to accept return of the Products and refund the purchase price less a reasonable allowance for depreciation. Seller has no obligation or liability for any claim of infringement: (i) arising from information provided by Buyer; or (ii) directed to any Products provided hereunder for which the designs are specified in whole or part by Buyer; or (iii) resulting from the modification, combination or use in a system of any Products provided hereunder. The foregoing provisions of this Section constitute Seller's sole and exclusive liability and Buyer's sole and exclusive remedy for such claims of infringement of Intellectual Property Rights.
- 20. Governing Law.** These Terms and the sale and delivery of all Products are deemed to have taken place in, and shall be governed and construed in accordance with, the laws of the State of Ohio, as applicable to contracts executed and wholly performed therein and without regard to conflicts of laws principles. Buyer irrevocably agrees and consents to the exclusive

jurisdiction and venue of the courts of Cuyahoga County, Ohio with respect to any dispute, controversy or claim arising out of or relating to the sale and delivery of the Products.

- 21. Entire Agreement.** These Terms, along with the terms set forth in the main body of any Quote, forms the entire agreement between the Buyer and Seller and constitutes the final, complete and exclusive expression of the terms of sale. In the event of a conflict between any term set forth in the main body of a Quote and these Terms, the terms set forth in the main body of the Quote shall prevail. All prior or contemporaneous written or oral agreements or negotiations with respect to the subject matter shall have no effect. These Terms may not be modified unless in writing and signed by an authorized representative of Seller.
- 22. Compliance with Laws.** Buyer agrees to comply with all applicable laws, regulations, and industry and professional standards, including those of the United States of America, and the country or countries in which Buyer may operate, including without limitation the U.S. Foreign Corrupt Practices Act ("FCPA"), the U.S. Anti-Kickback Act ("Anti-Kickback Act"), U.S. and E.U. export control and sanctions laws ("Export Laws"), the U.S. Food Drug and Cosmetic Act ("FDCA"), and the rules and regulations promulgated by the U.S. Food and Drug Administration ("FDA"), each as currently amended. Buyer agrees to indemnify, defend, and hold harmless Seller from the consequences of any violation of such laws, regulations and standards by Buyer, its employees or agents. Buyer acknowledges that it is familiar with all applicable provisions of the FCPA, the Anti-Kickback Act, Export Laws, the FDCA and the FDA and certifies that Buyer will adhere to the requirements thereof and not take any action that would make Seller violate such requirements. Buyer represents and agrees that Buyer will not make any payment or give anything of value, directly or indirectly, to any governmental official, foreign political party or official thereof, candidate for foreign political office, or commercial entity or person, for any improper purpose, including the purpose of influencing such person to purchase Products or otherwise benefit the business of Seller. Buyer further represents and agrees that it will not receive, use, service, transfer or ship any Product from Seller in a manner or for a purpose that violates Export Laws or would cause Seller to be in violation of Export Laws.

Parker Fluid Connectors Group

North American Divisions & Distribution Service Centers

Your complete source for quality tube fittings, hose & hose fittings, brass & composite fittings, quick-disconnect couplings, valves and assembly tools, locally available from a worldwide network of authorized distributors.

Fittings:

Available in inch and metric sizes covering SAE, BSP, DIN, GAZ, JIS and ISO thread configurations, manufactured from steel, stainless steel, brass, aluminum, nylon and thermoplastic.

Hose, Tubing and Bundles:

Available in a wide variety of sizes and materials including rubber, wire-reinforced, thermoplastic, hybrid and custom compounds.

Worldwide Availability:

Parker operates Fluid Connectors manufacturing locations and sales offices throughout North America, South America, Europe and Asia-Pacific.

For information, call toll free...

**1-800-C-PARKER
(1-800-272-7537)**

North American Divisions

Fluid System Connectors Division

Otsego, MI
phone 269 694 9411
fax 269 694 4614

Hose Products Division

Wickliffe, OH
phone 440 943 5700
fax 440 943 3129

Parflex Division

Ravenna, OH
phone 330 296 2871
fax 330 296 8433

Quick Coupling Division

Minneapolis, MN
phone 763 544 7781
fax 763 544 3418

Tube Fittings Division

Columbus, OH
phone 614 279 7070
fax 614 279 7685

Distribution Service Centers

Buena Park, CA

phone 714 522 8840
fax 714 994 1183

Conyers, GA

phone 770 929 0330
fax 770 929 0230

Louisville, KY

phone 502 937 1322
fax 502 937 4180

Portland, OR

phone 503 283 1020
fax 503 283 2201

Toledo, OH

phone 419 878 7000
fax 419 878 7001
fax 419 878 7420
(FCG Kit Operations)

Canada

Milton, ONT

phone 905-693-3000
fax 905-876-1958
(Contact Milton for other Service Center locations.)

Mexico

Toluca, MEX

phone (52) 722 2754 200
fax (52) 722 2722 168

